

ANALISI STRUTTURE ISOSTATICHE

Riportare sul fronte:

- 1) Reazioni calcolate
- 2) Diagrammi finali delle azioni interne

Sul retro:

- 3) Analisi cinematica

Carichi e deformazioni date hanno verso efficace in disegno.

Calcolare reazioni vincolari della struttura e delle aste.

Tracciare i diagrammi quotati delle azioni interne nelle aste.

@ Adolfo Zavelani Rossi, Politecnico di Milano, vers.27.03.13



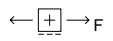
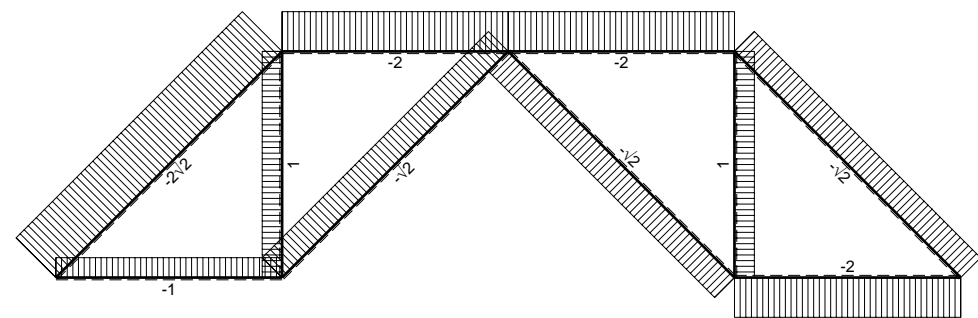
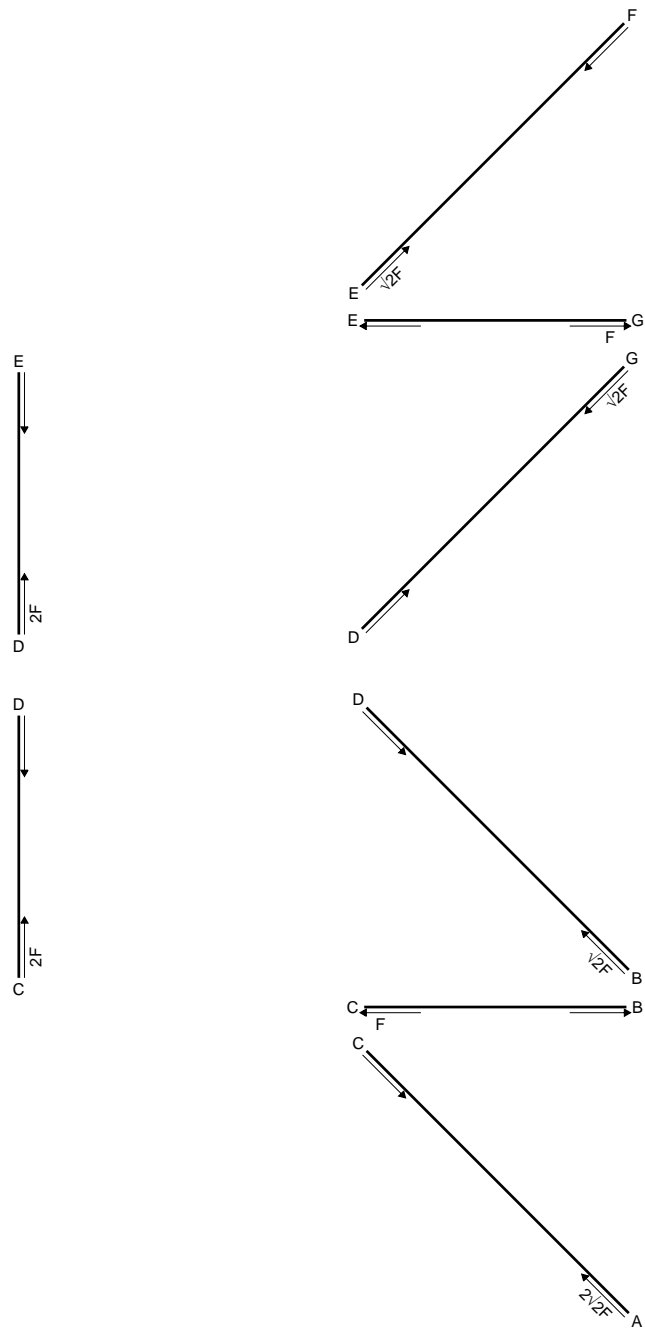

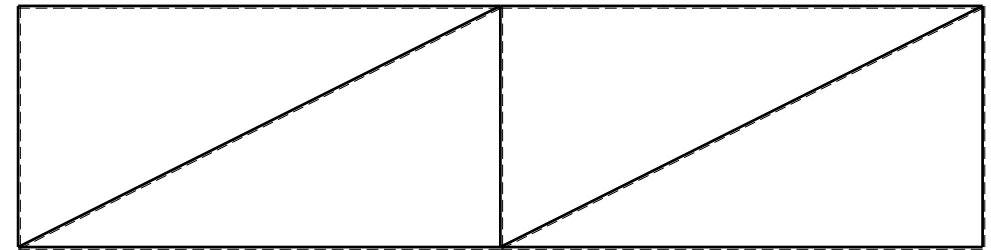
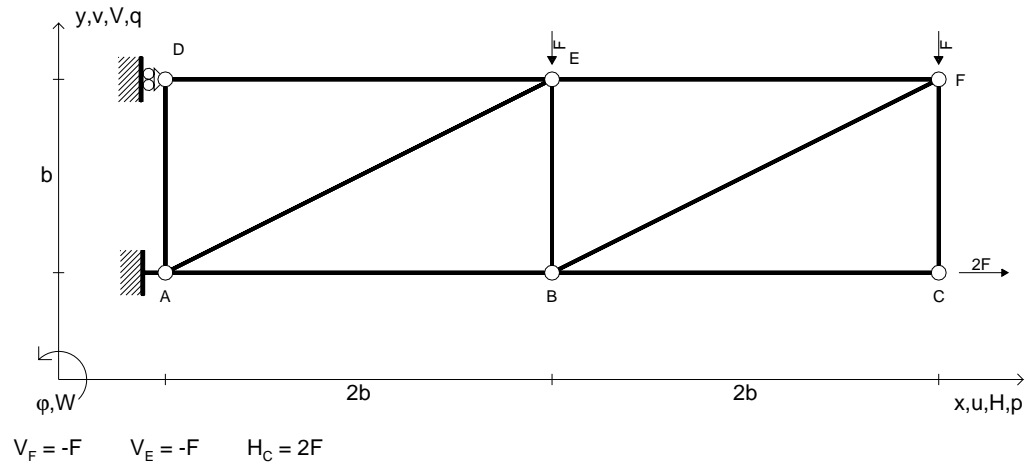

ANALISI STRUTTURE ISOSTATICHE

Riportare sul fronte:

- 1) Reazioni calcolate
- 2) Diagrammi finali delle azioni interne

Sul retro:

- 3) Analisi cinematica

Carichi e deformazioni date hanno verso efficace in disegno.

Calcolare reazioni vincolari della struttura e delle aste.

Tracciare i diagrammi quotati delle azioni interne nelle aste.

@ Adolfo Zavelani Rossi, Politecnico di Milano, vers.27.03.13



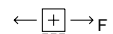
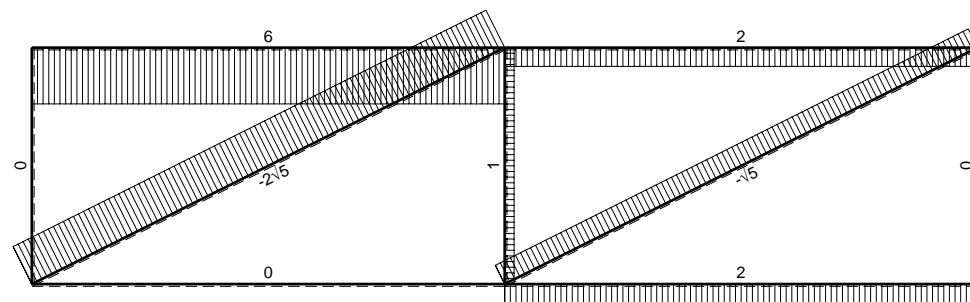
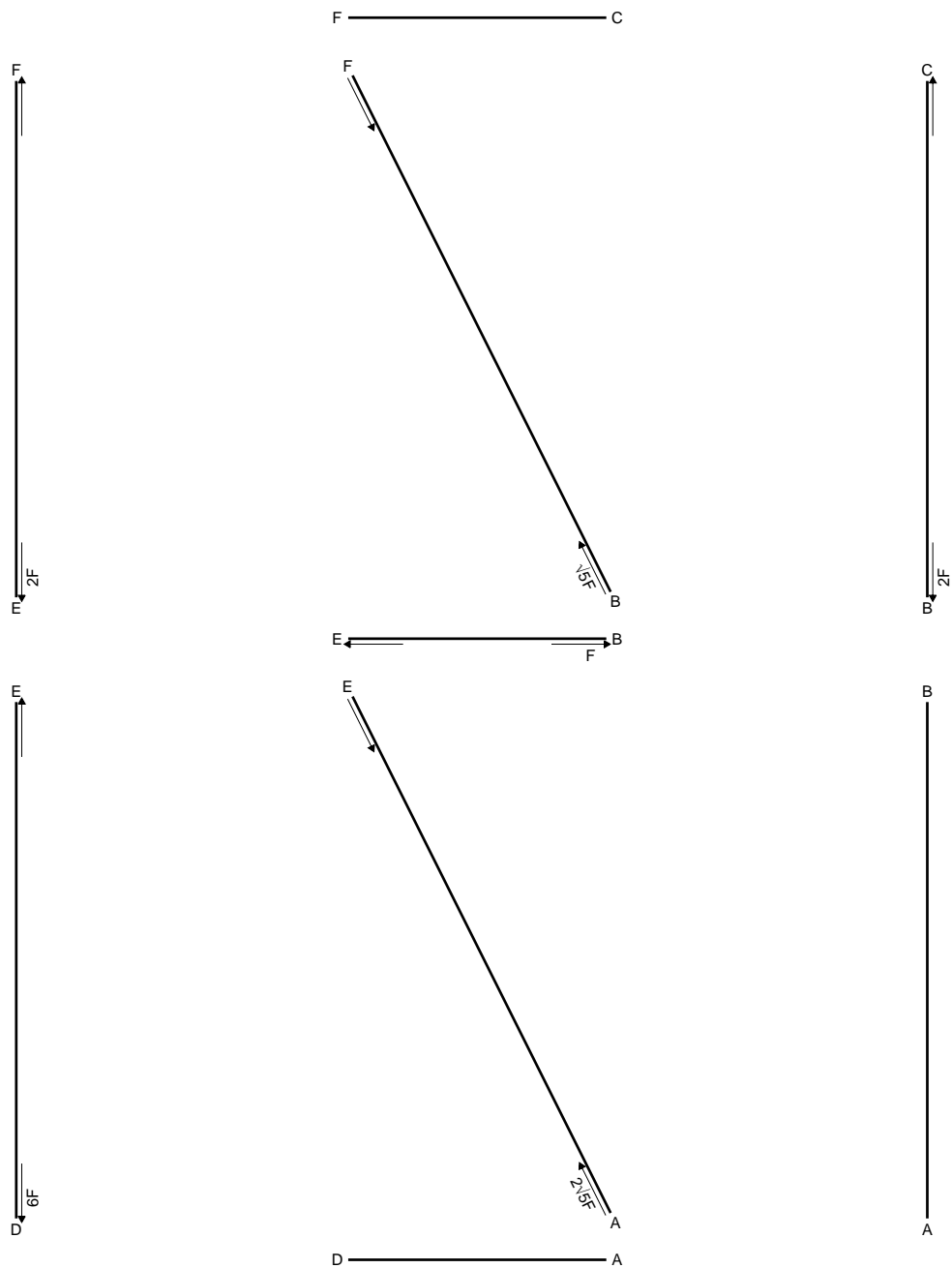

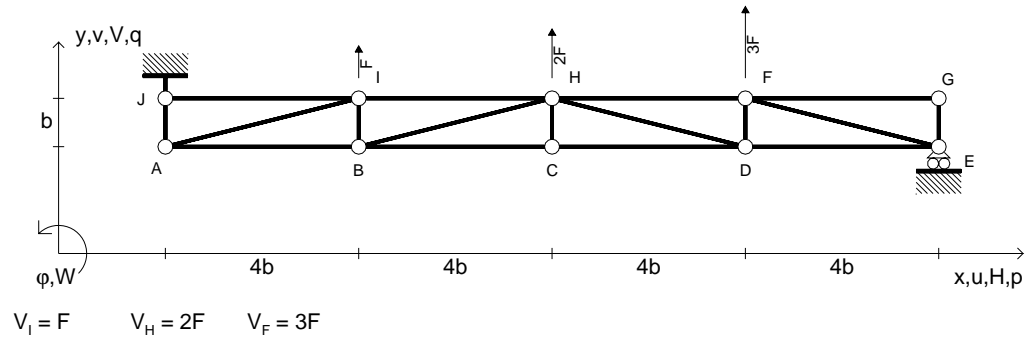

Carichi e deformazioni date hanno verso efficace in disegno.  
 Calcolare reazioni vincolari della struttura e delle aste.  
 Tracciare i diagrammi quotati delle azioni interne nelle aste.  
 © Adolfo Zavelani Rossi, Politecnico di Milano, vers.27.03.13



